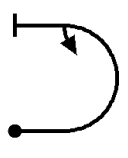
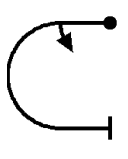
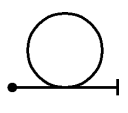
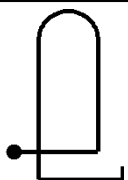
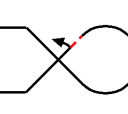
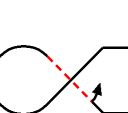
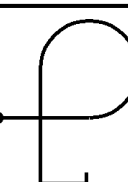
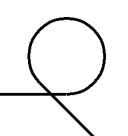

Pilot ID #

Flight #

No	Symbol	Catalog No	K	Tot K	Score	Remarks
1		7.2.1 9.1.3.2	6 4	10		
						sf=7
2		7.3.3 9.1.3.2	6 4	10		
						sf=7
3		7.5.1	10	10		
						sf=7
4		8.1.1	13	13		
						sf=7
5		7.20.1 9.1.2.2	14 6	20		
						sf=7
6		7.21.3 9.1.4.2	14 4	18		
						sf=7
7		8.43.1	11	11		
						sf=7
8		8.45.1	11	11		
						sf=7

Item	K	Score
Positioning		
PENALTIES	Interruptions	
	Insertions	
	Too high	
	Too low	
	Outs	
	Other	
Disqual Fig #		
T/O time		
End time		

Fig K
103

Total K

Judges Details

Signature

Name

Number

pilot

A/C

		FORM B
Pilot ID #		Flight #

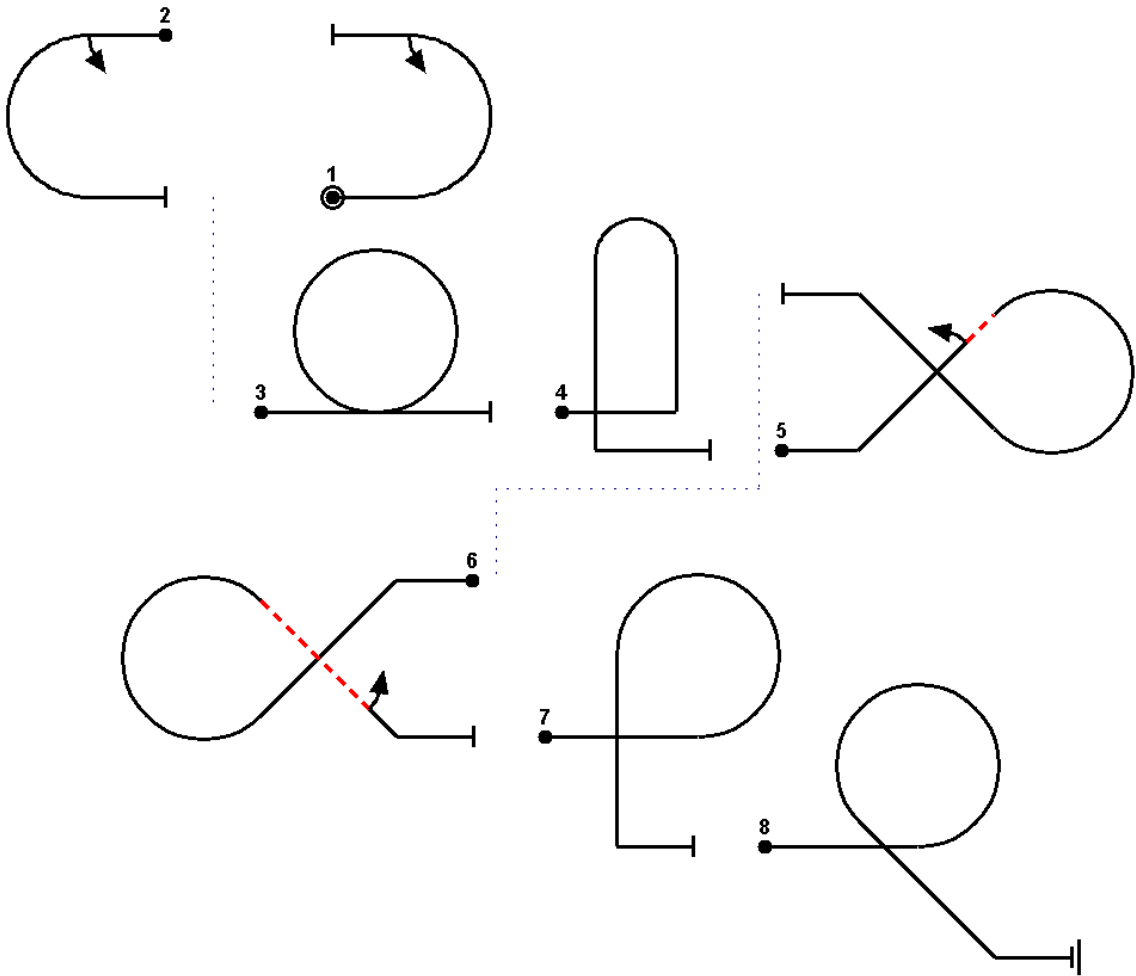

Total K = 103 (10k@1,20k@5)

Olanbeta v0.8 © M. Golian <http://www.aerobatics.org.il/olian>

No Verification information available for this sequence type: ..
m2 2a o b 2g ig2 p q

Pilot

A/C

FORM C

Pilot ID #

Flight #

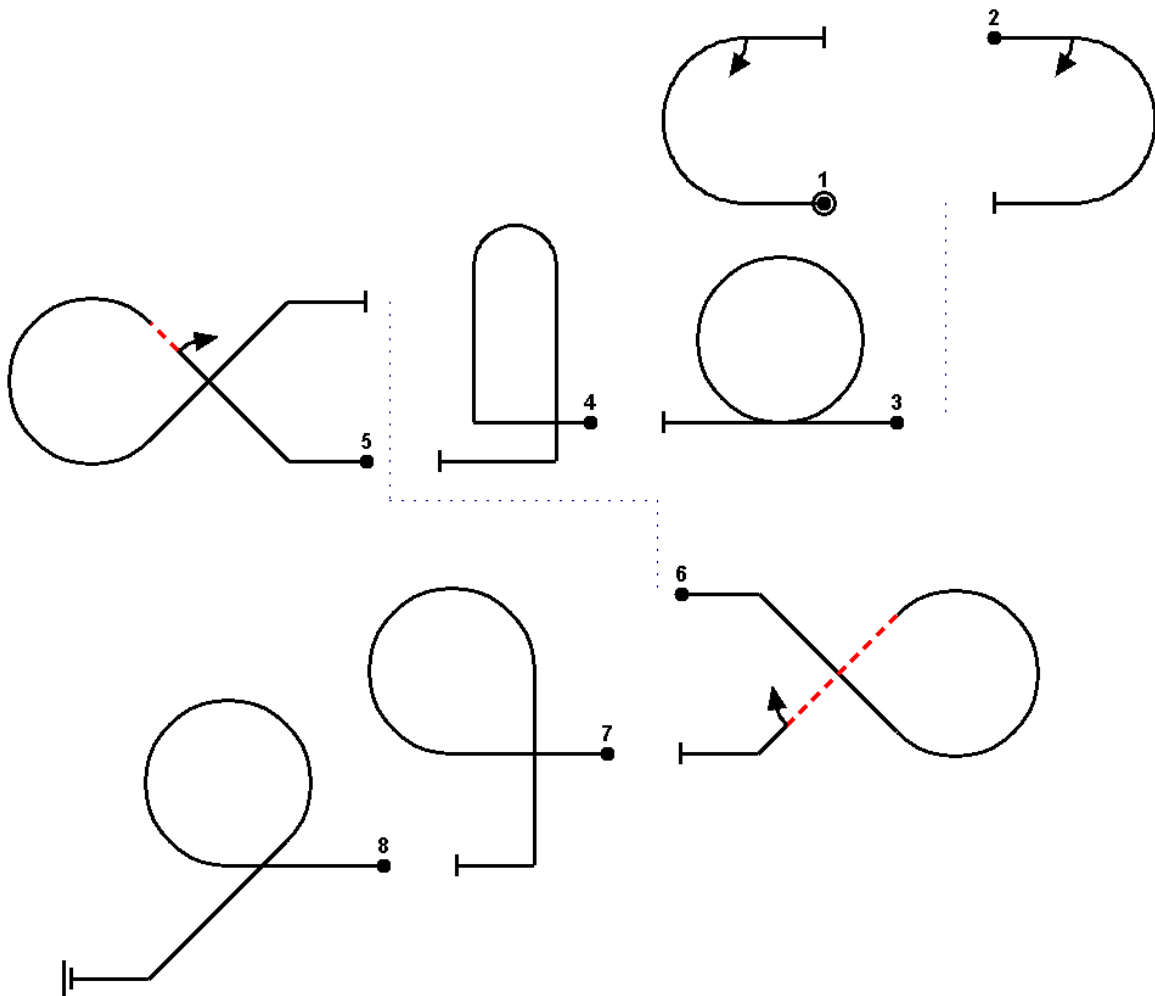

Total K = 103 (10k@1,20k@5)

